

ARMAÇÃO POSITIVA DAS LAJES

Esc.: 1:50

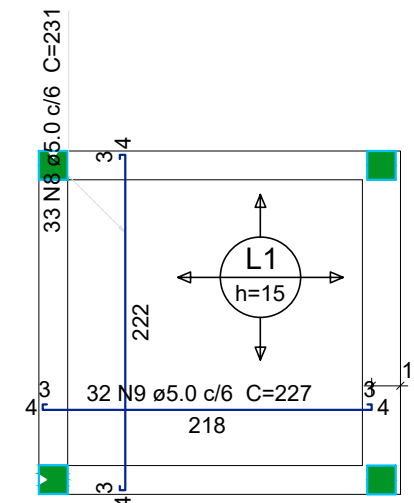

ARMAÇÃO NEGATIVA DAS LAJES

Esc.: 1:50

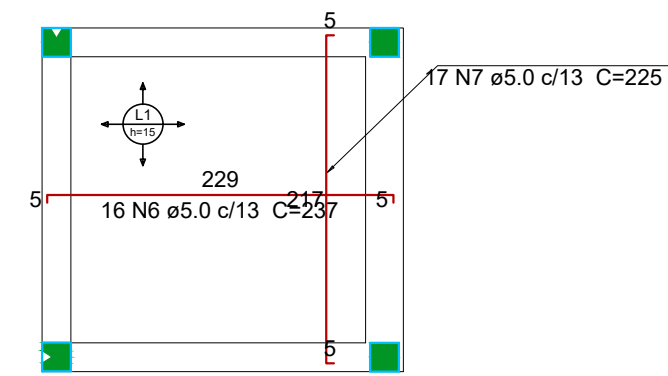

Relação do aço

AÇO	N	DIAM (mm)	QUANT	C.UNIT (cm)	C.TOTAL (cm)	
Negativos Positivos VC3	7xP1	P4				
	VC1	VC2				
	VC4	VC5				
	CA60	1	5.0	189	68	12852
		2	5.0	27	90	2430
		3	5.0	65	110	7150
		4	5.0	15	122	1830
		5	5.0	24	102	2448
		6	5.0	16	237	3792
		7	5.0	17	225	3825
		8	5.0	33	231	7623
		9	5.0	32	227	7264
	CA50	10	6.3	4	535	2140
		11	10.0	32	317	10144
		12	10.0	4	477	1908
		13	10.0	4	588	2352
		14	10.0	2	241	482
		15	10.0	2	285	570
		16	10.0	2	525	1050
	17	12.5	2	421	842	
	18	12.5	2	414	828	
	19	12.5	2	549	1098	

Resumo do aço

AÇO	DIAM (mm)	C.TOTAL (m)	QUANT + 10 % (Barras)	PESO + 10 % (kg)
CA50	6.3	21.4	2	5.8
	10.0	165.1	16	111.9
	12.5	27.7	3	29.3
CA60	5.0	492.2	46	83.4
PESO TOTAL (kg)				
CA50			147	
CA60			83.4	

Volume de concreto (C-25) = 3.13 m³
Área de forma = 44.81 m²

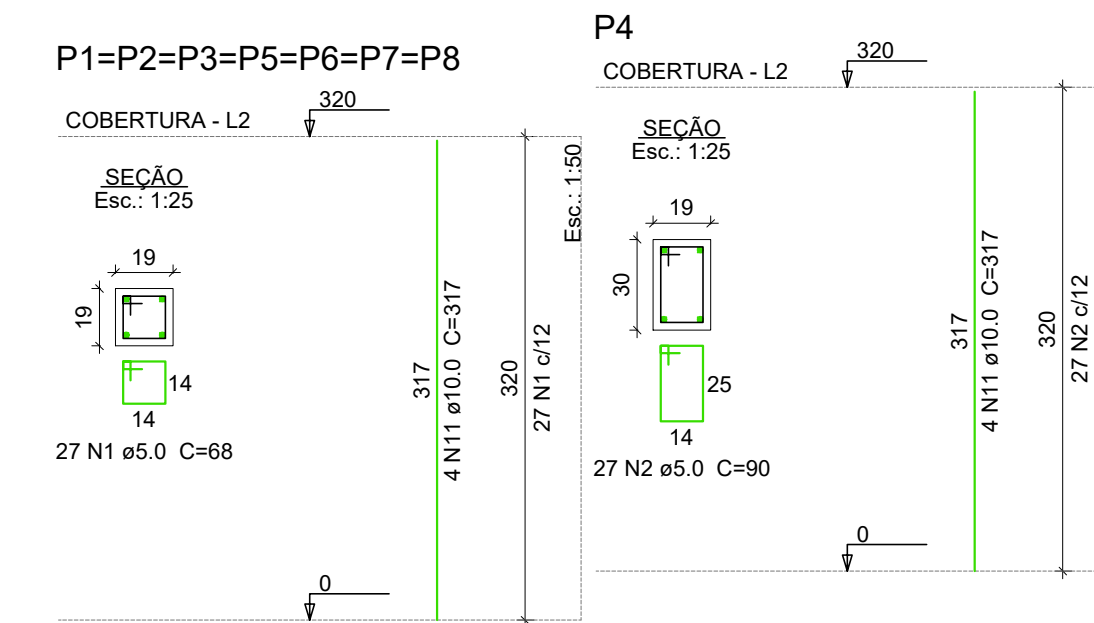

VC1 (19 x 40)

Esc.: 1:50

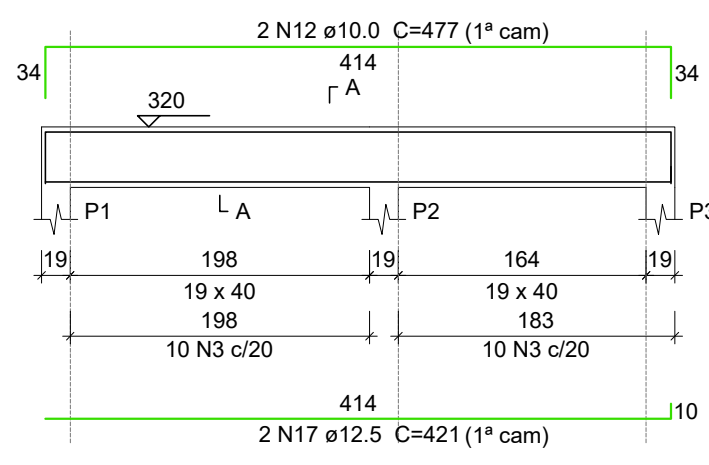

SEÇÃO A-A

Esc.: 1:25

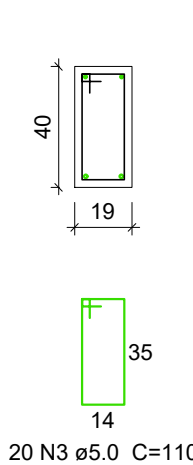

VC2 (19 x 40)

Esc.: 1:50

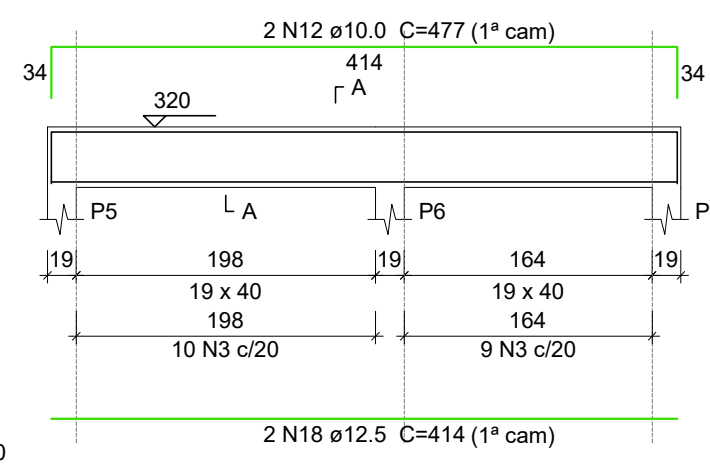

SEÇÃO A-A

Esc.: 1:25

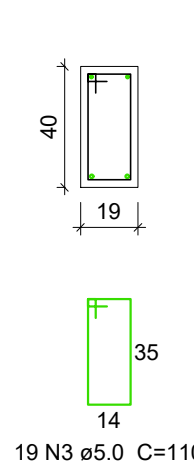

VC3 (19 x 40)

Esc.: 1:50

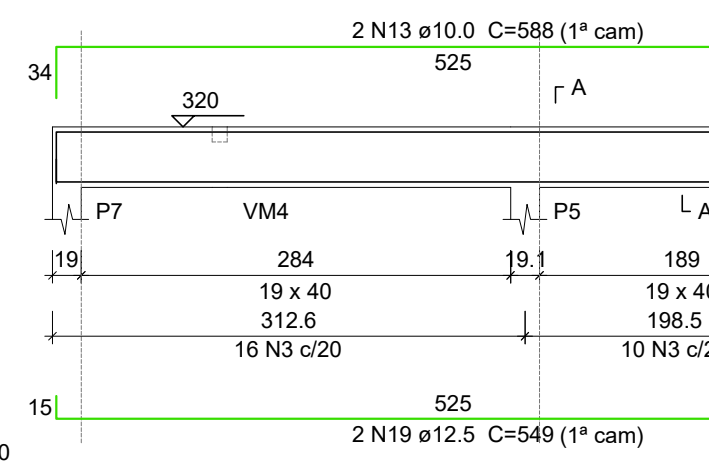

SEÇÃO A-A

Esc.: 1:25

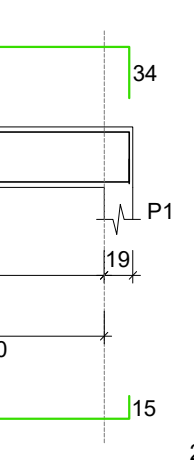

VC4 (25 x 40)

Esc.: 1:50

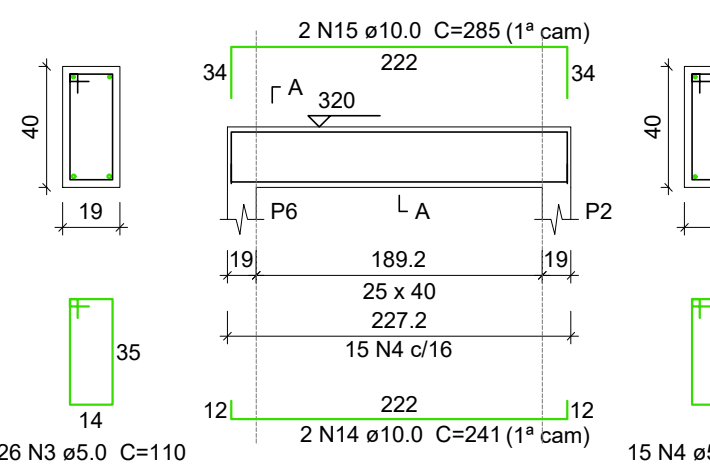

SEÇÃO A-A

Esc.: 1:25

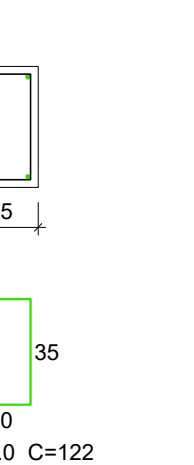

VC5 (15 x 40)

Esc.: 1:50

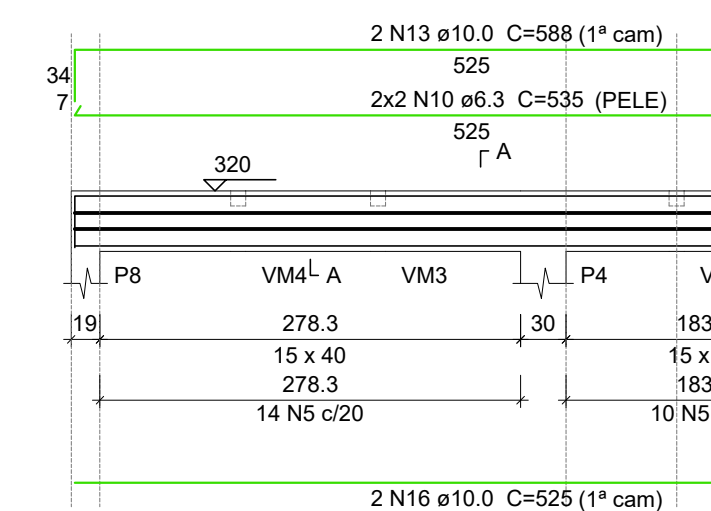

SEÇÃO A-A

Esc.: 1:25



TABELA FCK DA OBRA

Sapatas	25 mpa
Vigas, Lajes e Pilares	25 mpa
abatimento (slump) 10 +- 2cm	

REV.	DESCRIÇÃO	DATA	RESP.
01	LIBERADO PARA EXECUÇÃO	FEV/2022	João N.
00	ENVIADO PARA REVISÃO PREFEITURA	DEZ/2021	João N.

PROPRIETÁRIO:

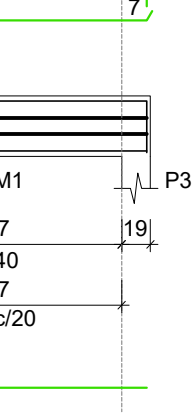
Prefeitura Municipal de Augusto Pestana

RESPONSÁVEIS TÉCNICOS:

JOÃO DA JORNADA FORTES FILHO
Arquiteto e Urbanista CAU A 52.256-2

MARIANA DA SILVA FERREIRA FORTES
Arquiteta e Urbanista CAU A 64.319-0

JOÃO DA JORNADA FORTES NETO
Engenheiro Civil CREA RS 214.992

ENDEREÇO:

Estrada Rural
Marmeleiro

CIDADE / UF:

Augusto Pestana / RS
QUADRA: ---
LOTE: ---

ÁREA A EDIFICAR:

CONJUNTO N°:

1

PRANCHA N°:

5 / 5

ÁREA DO LOTE:

DATA:

FEV/22